

VB – 2DA

2 Channels

Analog Output Module

User Manual

Foreword

- This manual contains text, diagrams and explanations which will guide the reader in the correct installation, safe use and operation of the VB-2DA analog output module. It should be read and understood before attempting to install or use the unit.
- Further information can be found in the VIGOR M, VB and VH series PLC PROGRAMMING MANUAL.
- If in doubt at any stage during the installation of the VB-2DA analog output module always consult a professional electrical engineer who is qualified and trained to the local and national standards.
- If in doubt about the operation or use of the VB-2DA analog output module please consult the nearest VIGOR ELECTRIC CORP. distributor.
- This manual is subject to change without notice.

Features

- Provides 2 channels analog output, each one has 12-bit high precision resolution.
- The voltage (0 V ~ +10 V) or current (+4 mA ~ +20 mA) output can be specified for each channel independently.
- The OFFSET and GAIN of each output channel can adjust independently.
- Photocoupler isolation between output analog signals and digital PLC circuits. Inner DC to DC isolated converter supplies the clean power.

Instruction

- VB-2DA Analog Output Module contains 2 channels of analog outputs. Each output channel receives a 12-bit digital signal from the PLC then converts that to an analog (either voltage or current) signal output.
- Through the operation of the FROM / TO instruction, such digital data can be transferred for monitoring the status of VB-2DA, and furthermore data from the VB Series Main Unit for relative analog control outputs.
- Please read this user manual carefully before using the VB-2DA Analog Outputs Module.
- The default modes are good enough for general applications, please refer to the Chapters #1 ~ #6; for a particular digital to analog transfer characteristic, please study the Chapter #7.

Contents:	Page:
<u>1. Specifications</u>	2
<u><< Power Requirement >></u>	2
<u><< Performance Specifications >></u>	3
<u><< Charts of D/A Converter Characteristic >></u>	3
<u>2. Dimensions</u>	3
<u>3. Terminal Layouts</u>	4
<u>4. Outline of FROM/TO Instruction</u>	5
<u>5. Allocation of Buffer Memory (BFM)</u>	6
<u>6. Operation and Program Example</u>	8
<u>Cautions Regarding Operation</u>	9
<u>7. Defining OFFSET and GAIN</u>	10

1. Specifications

- The VB-2DA analog output module has two output channels. The output channels take in a digital value and output an equivalent analog (voltage or current) signal. This is called a D/A conversion. The VB-2DA has maximum resolution of 12 bits.
- The selection of voltage or current based output is by user wiring. Analog ranges of 0 ~ 10 V DC , and/or 4 ~ 20 mA maybe selected independently for each channel.
- The VB-2DA analog output module is attached as an extension to the VB series Programmable Logical Controller (hereinafter referred to as “PLC”), and the VB-2DA is attached as an extension to the VB series PLC Main Unit. Each VB-2DA functions as a special module which transfers data with the PLC using the FROM / TO instructions, and would not occupy any input or output point. Up to 8 special modules can be connected to single VB2 series PLC; a single VB0 series PLC can connect with two special modules.

<< Power Requirement >>

- 5 V DC (for internal control)
 - Supplied from PLC Main Unit (or Expansion Unit) via its extension cable.
 - From a Main Unit:
[(The amount of Expansion Modules) + (The amount of Special Modules) X 2] ≤ 4
 - From a Expansion Unit or VB-PWR:
[(The amount of Expansion Modules) + (The amount of Special Modules) X 2] ≤ 12
- 24 V DC (+20% / -15%), 100 mA Max. (for analog signal output)
 - Supplied from external power supply or 24 V DC output of PLC.

<< Performance Specifications >>

Item	Voltage Output	Current Output
	Voltage or Current outputs are selected by BFM #20 & different terminals	
Mode	0	1
Analog Output Range (DC)	0 ~ +10 V	+4 ~ +20 mA
Digital Input Range	0 ~ +4000	0 ~ +4000
External Load Resistance	500 Ω ~ 1 MΩ	500 Ω or less
Resolution	2.5 mV	5 μA
Overall Accuracy	± 1% (full scale)	
Conversion Speed	0.4 ms / 2 points	
Isolation	Photocoupler isolation between analog and digital circuits. DC/DC converter isolates of power from its power source. No isolation between analog channels.	

<< Charts of D/A Converter Characteristic >>

The charts of two default D / A converted characteristics. (Which can be adjusted by using the approach specified at [Chapter #7: Defining OFFSET and GAIN.](#))

Mode 0: Voltage Output (Range: 0 V ~ +10 V) Mode 1: Current Output (Range: +4 mA ~ +20 mA)

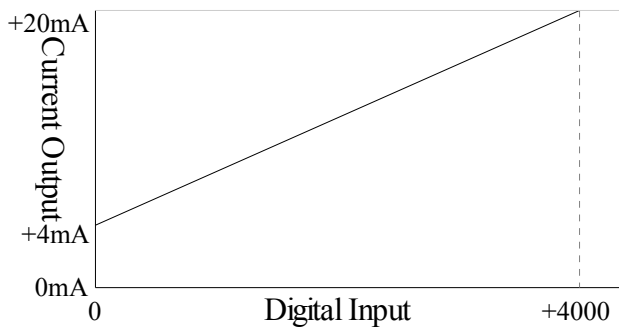
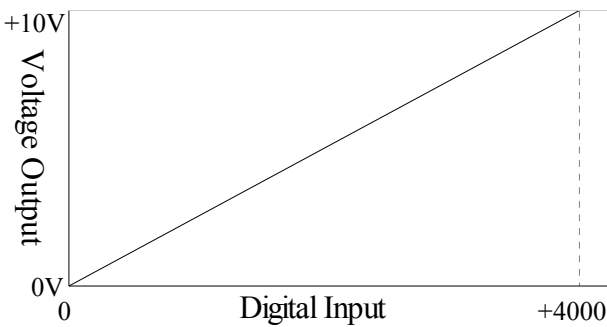

2. Dimensions

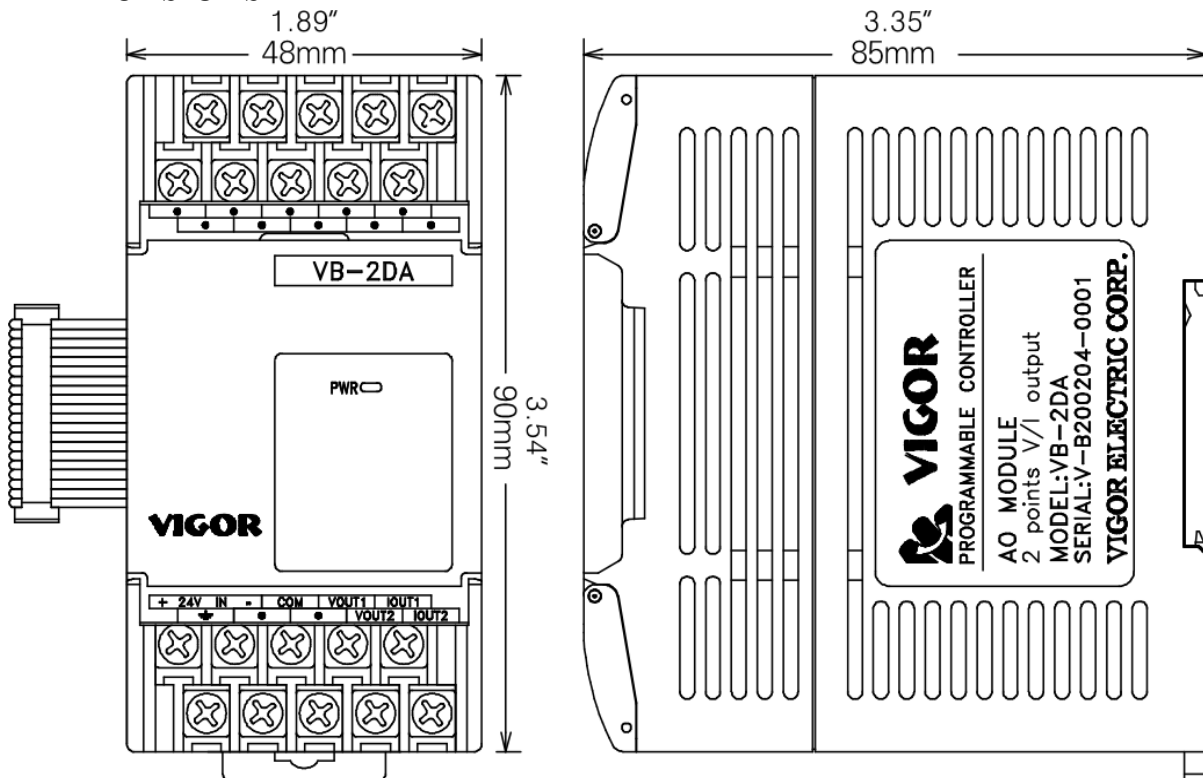

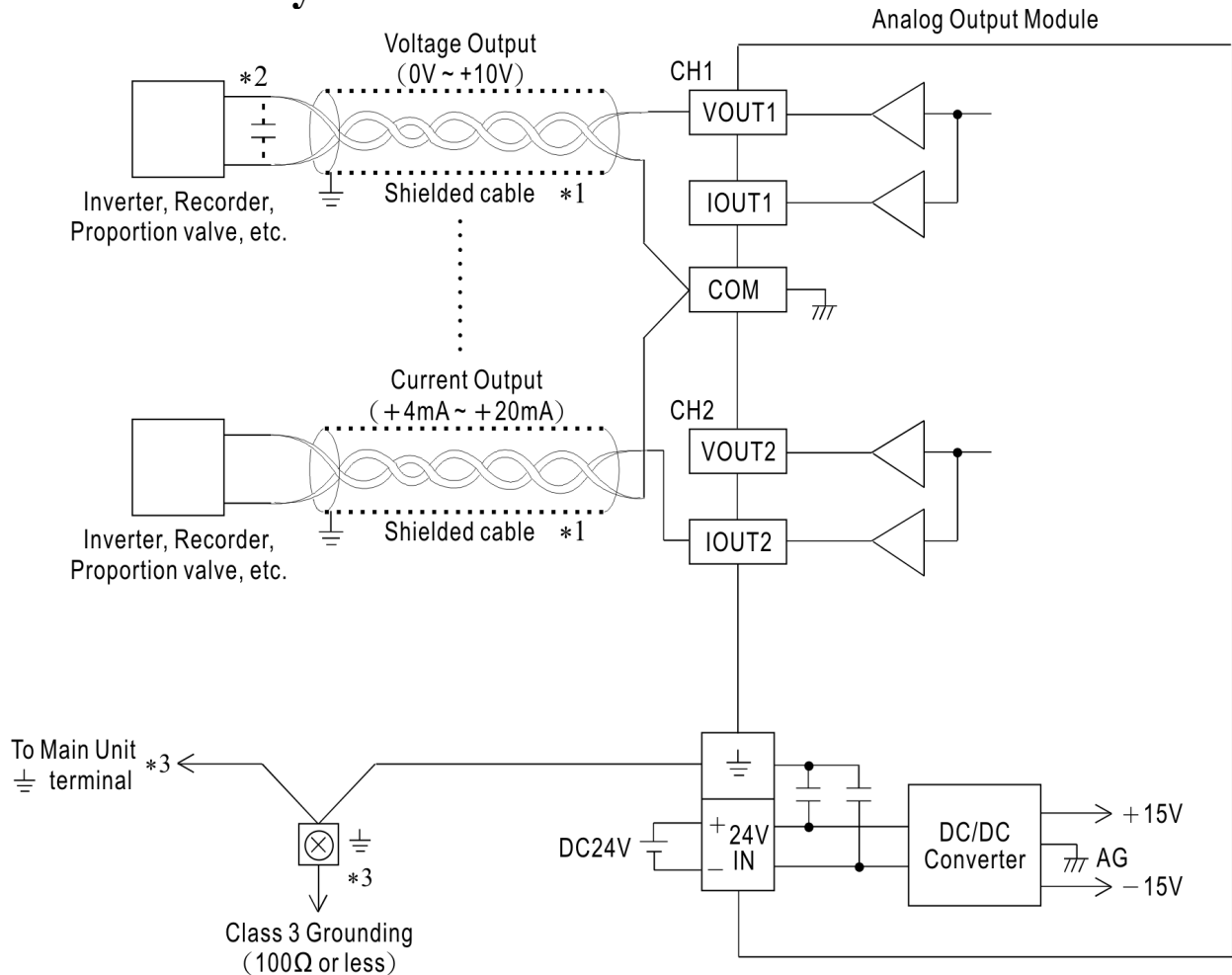

3. Terminal Layouts



- *1: Please use the Shield Twisted-Pair isolation cable for each analog output channel and keep the cable away from the electromagnetic interference source (ex. power lines or any other lines which may induce electrical noise). Apply 1-point grounding at the load side of the output cable (class 3 grounding: 100 Ω or less).
- *2: If electrical noise or a voltage ripple exists at the output, must connect a smoothing capacitor of 0.1 ~ 0.47 μF, 25 V.
- *3: Connect the ≡ terminal on the VB-2DA with the ≡ terminal on the Main Unit of the programmable controller.

- Mixed (voltage and current) output from the same channel is not possible.
- Shorting the voltage output terminal or connecting the current output load to the voltage output terminal may damage the VB-2DA.
- The 24 V DC service power of the PLC Main Unit can also be used.
- Do not connect any unit to the unused terminal.

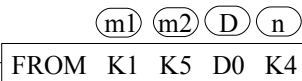
4. Outline of FROM/TO Instruction

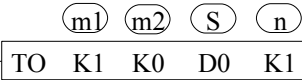
D	FNC 78 FROM	P		Read special module BFM												
Device																
	X	Y	M	S	KnX	KnY	KnM	KnS	T	C	D	SD	P	V,Z	K,H	VZ index
m1															○	
m2															○	
D						○	○	○	○	○	○					○
n															○	
● m1 = 1~8 ● m2 = 0~32767 ● n = 1~32767																
X0			<p>(m1): The position number of the specified special module (m2): Initial serial number of the BFM(s) to be read (D): The initial device of storage(s) for collect the picked up data (n): Number of data group(s) to be read</p>													
<ul style="list-style-type: none"> ● The Main Unit of VB Series PLC use the instruction to read BFM data of the special module. ● When X0="ON", 4 groups (they will be the BFM #5~#8, because (n)= K4 and (m2)= K5) data in the specified special module (which is installed in the (m1)= K1 = 1st. position) will be read and stored into registers sequentially which are started from (D)= D0 . ● To assign the (m1) in a VB Series, each special module is consecutively assigned from K1 to K8 (in a VB0 Series, (m1)= K1 or K2), it begins with the closest one to the Main Unit. ● When X0="OFF", the instruction will not be performed but the data (which was read previously) will still remain. 																
D	FNC 79 TO	P		Special module BFM write in												
Device																
	X	Y	M	S	KnX	KnY	KnM	KnS	T	C	D	SD	P	V,Z	K,H	VZ index
m1															○	
m2															○	
S				○	○	○	○	○	○	○	○				○	○
n															○	
● m1 = 1~8 ● m2 = 0~32767 ● n = 1~32767																
X0			<p>(m1): The position number of the specified special module (m2): Initial serial number of the BFM(s), which will be written (S): The initial source device, which stores the data is for the BFM (n): Number of data group(s) to be write</p>													
<ul style="list-style-type: none"> ● The Main Unit of VB series PLC use this instruction to write data to the special module BFM. ● When X0="ON", the content value of (S) (D0) will be written into the BMF #0 ((m2) = K0) in the special module and it is installed in the 1st ((m1)= K1) position. Since (n) = K1, there is only one BFM will be written. ● To assign the (m1) in a VB Series, each special module is consecutively assigned from K1 to K8 (in a VB0 Series, (m1)= K1 or K2), it begins with the closest one to the Main Unit. ● When X0="OFF", the instruction will not be performed but the data (which was written previously) will still remain. 																

5. Allocation of Buffer Memory (BFM)

Data is transmitted between the VB-2DA and the Main Unit via buffer memories (BFM).

BFM	Description	
#20	Output mode select	Default value = H00 (with latch function)
#21	CH #1 Output data	Default value = 0 (when the PLC power, OFF→ON)
#22	CH #2 Output data	
#23	Data holding mode	Default value = H00 (with latch function)

- The value of BFM #20 switches the analog output between voltage and current on each channel. It takes the form of a 2-digit hexadecimal number. The first digit will be the command for the channel 1 (CH1), and the second digit is for the channel 2 (CH2). The numeric values of these 2 digits respectively represent the following items:

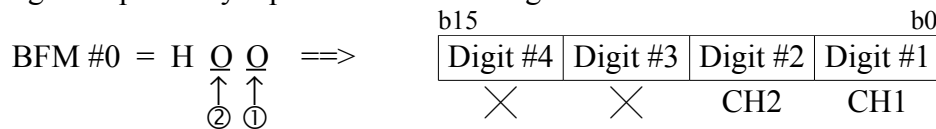

When: $\text{Q} = 0$: Sets the channel to voltage output mode (0 V ~ +10 V).

$\text{Q} = 1$: Sets the channel to current output mode (+4 mA ~ +20 mA).

Switching the output mode resets the I/O characteristics to the factory-set characteristics. Refer to the section of << **Charts of D/A Converter Characteristic** >>.

Example: Let the BFM #0 = H 1 0

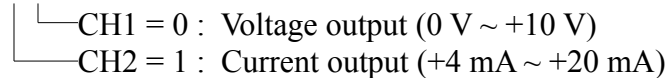

- While the programmable controller is in the STOP mode, the last output value in the RUN mode could be hold. To write a hexadecimal value in BFM #23 as follows can choose its analog output status (at the RUN→STOP condition).

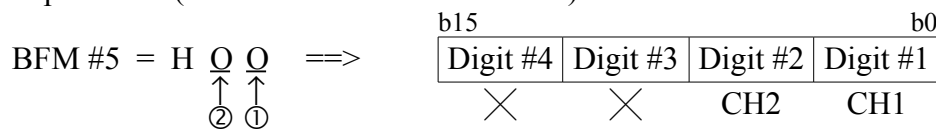

When: $\text{Q} = 0$: Sets the channel to hold the output value. (If the PLC RUN→STOP)

$\text{Q} = 1$: Sets the channel to the lowest output (OFFSET) value. (If the PLC RUN→STOP)

Ex. When the power of PLC is kept ON and switched the Main Unit RUN→STOP.

If BFM #23=H00 => Both the CH2 & CH1 will hold their output

If BFM #23=H01 => The CH2 will hold its output, the CH1's output=OFFSET value

If BFM #23=H10 => The CH2's output=OFFSET value, the CH1 will hold its output

If BFM #23=H11 => Both the output of CH2 & CH1 = their own OFFSET values

- The value of BFM #20 ~ #23 can be written from its Main Unit by using the TO instruction.

BFM	Description
#24	To activate the excepted settings
#25	The OFFSET value of the CH1 (Default value = K0)
#26	The GAIN value of the CH1 (Default value = K5,000)
#27	The OFFSET value of the CH2 (Default value = K0)
#28	The GAIN value of the CH2 (Default value = K5,000)
#29	When its b0 = 1, all the A/D converted characteristics will be returned to the default values.
#30	Model code: K102 (Read only)

- When to trigger the BFM #29, b0 = 1, all the analog to digital converted characteristics (including CH1 & CH2) will be returned to the default values. If a user sets incorrect converted characteristics to a VB-2DA, to trigger the BFM #29, b0 =1 which can reset all the converted characteristics back to their default settings.
- When to trigger the BFM #24 (b1,b0) = (1,1), the content values of BFM #25 and #26 (which are the converted characteristics for CH1) will be activated and recorded to the EEPROM. And so forth, the (b3,b2) in the BFM #24 can use the same effect on the CH2, which may be set up the CH1 & CH2 respectively or simultaneously.

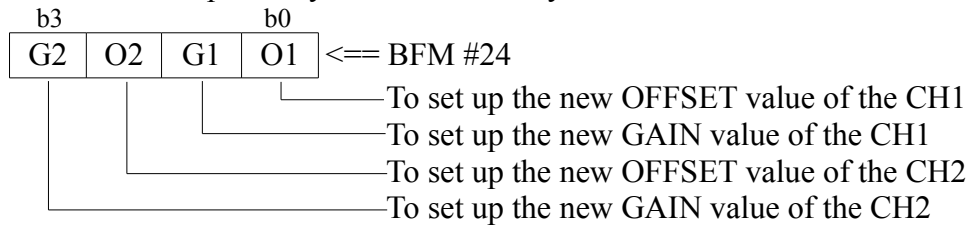

- The settings of BFM #25 ~ #28 shall be in the unit of mV or μ A, which are specified by the input mode of BFM #20.
- The BFM #24 ~ #29 can be written from its Main Unit by using the TO instruction; the BFM #30 can be read to its Main Unit by using the FROM instruction.
- To adjust the conversion characteristics. First, the OFFSET value and GAIN value of the channel are required to be written (in BFM #25 ~ #28); and then, to trigger the corresponding bit in BFM #24.

Cautions

- The content value of BFM #20, BFM #23, OFFSET and GAIN settings (BFM #25 ~ #28) of each channel will be kept in EEPROM of the VB-2DA module. Also, to reset the settings by BFM #29 will rewrite the data in EEPROM. The rewrite times of EEPROM is 10,000 times approximately; to operate those BFMs (#20, 23, 24 and 29) should pay attention to this limitation of EEPROM.
- Writing data into an EEPROM will take longer time. So between two rewrite commands for the EEPROM, must make an interval (more than one second).

6. Operation and Program Example

To operate the VB-2DA can using the following simple programs.

Example #1:

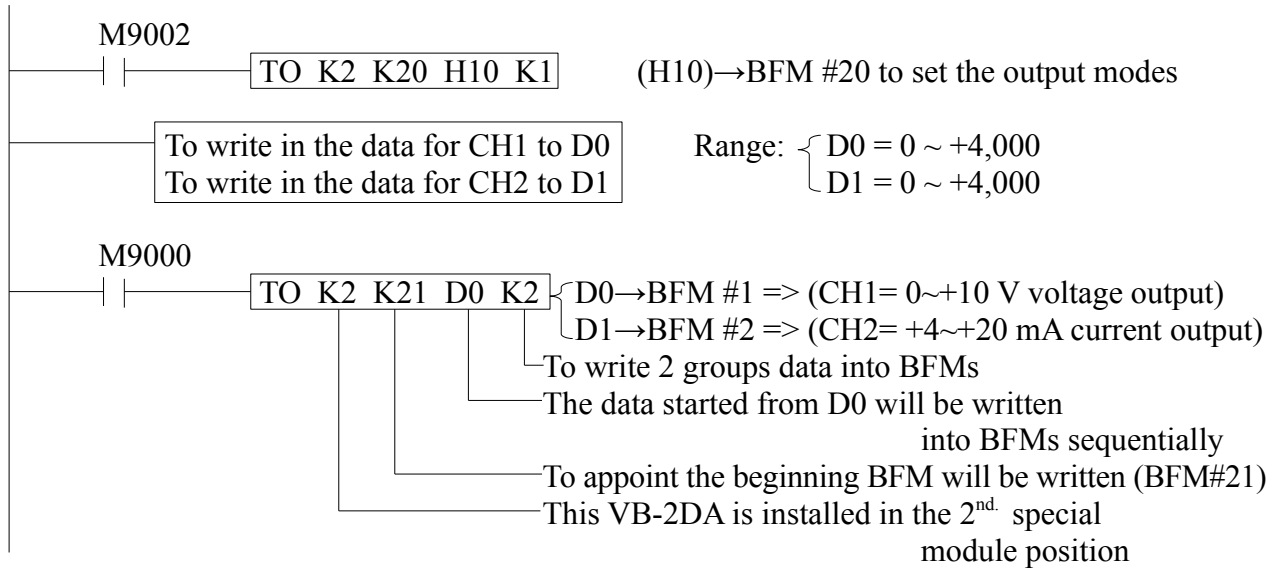

- In this program, the BFM #20 = H10 :
 - The digit #1 = 0, CH1 will be a 0 ~ +10 V voltage output.
 - The digit #2 = 1, CH2 will be a +4 ~ +20 mA current output.

Operation procedure:

- ① Turn OFF the power of the Main Unit, and then connect the VB-2DA (in the program this module is installed in the 2nd special module position). After that, wire the I/O and power lines of the VB-2DA.
- ② Set the Main Unit to STOP, and turn ON the power. To download the above program then switch the Main Unit to RUN.
- ③ Analog values will be sent from D0 (BFM #1) and D1 (BFM #2) to the respective output channels of the VB-2DA. When the Main Unit is in STOP, the analog outputs will be remain (those values has been set before stopping).
- ④ To set the values of D0 and D1, the analog outputs of VB-2DA will follow digital inputs. For a detailed description, refer to [Chapter #5: Allocation of Buffer Memory \(BFM\)](#).

Example #2:

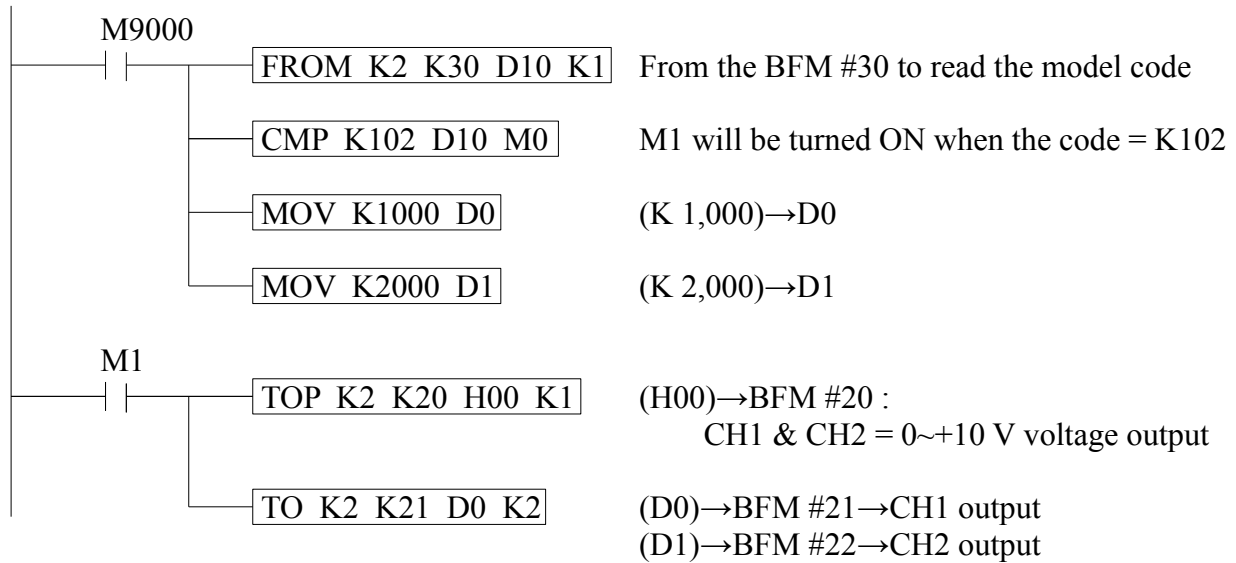

- To execute the program above, on the VB-2DA terminals will be:
 Between VOUT1 and COM has 2.5 V output.
 Between VOUT2 and COM has 5 V output.

Cautions Regarding Operation

- ① Check whether the output wiring and/or expansion cables are properly connected on VB-2DA analog output module. (Refer to [Chapter #3: Terminal Layouts](#))
- ② Check that the VB system configuration rules have not been broken, i.e. the number of modules does not exceed 8.
- ③ Ensure that the correct output mode has been selected for the application.
- ④ Check that there is no power overload on either the 5 V or 24 V [Power Requirement](#), remember the loading on the VB Main Unit or a powered extension unit varies according to the number of extension units or special function units connected.
- ⑤ Put the Main Unit into RUN.
- ⑥ After turning ON or OFF the 24 V DC power for analog signals, the analog output may fluctuate for approximately 1 second. This is due to time delays in the power supply from the Main Unit or differences in start time. For this reason, be sure to take preventive measures so that this output fluctuation will not affect the external units.

7. Defining OFFSET and GAIN

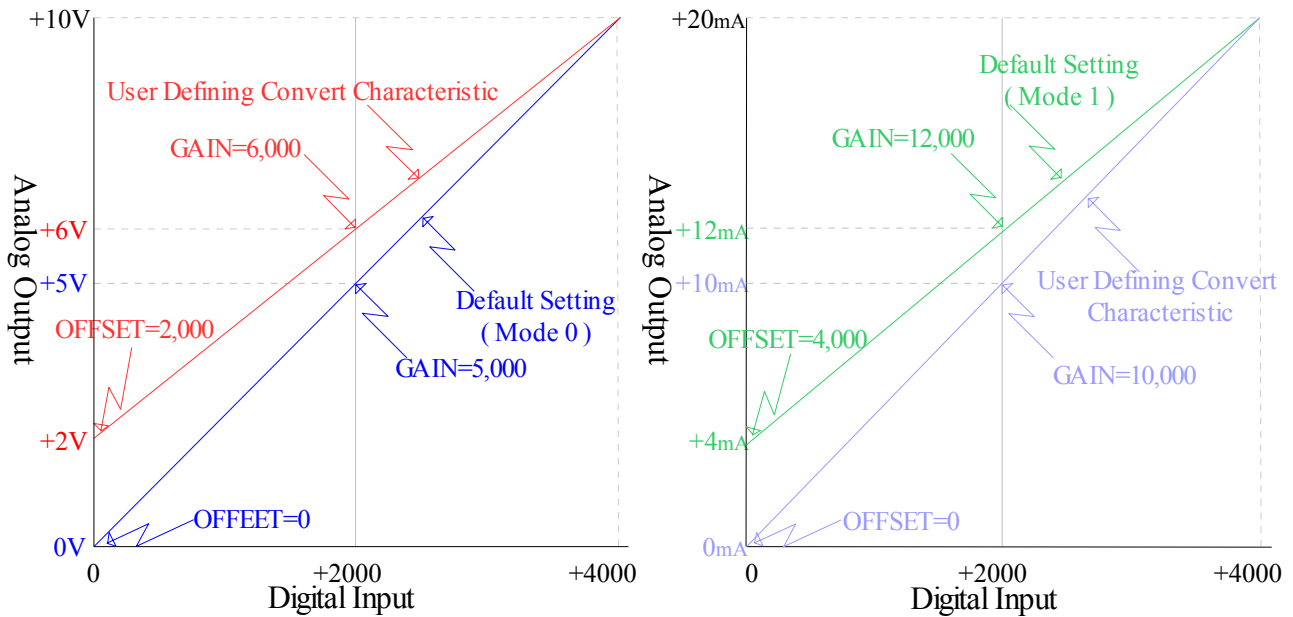

D/A Conversion Chart of Voltage Output Modes D/A Conversion Chart of Circuit Output Modes

The two diagrams above represent Digital to Analog conversion characteristic charts of the voltage output mode and the circuit output mode. Users may adjust those conversion characteristic charts depending on actual needs for particular application. To change the OFFSET value and GAIN value, the adjustment principles are specified as follows:

- **OFFSET** is the 'Position' of the calibrated line, identified at a digital input value of 0. The unit is mV or μ A.

- (a) Positive offset
- (b) Zero offset

Available range of OFFSET:

Voltage output: 0 V (0) ~ +5 V (+5,000)

Current output: 0 mA (0) ~ +20 mA (+20,000)

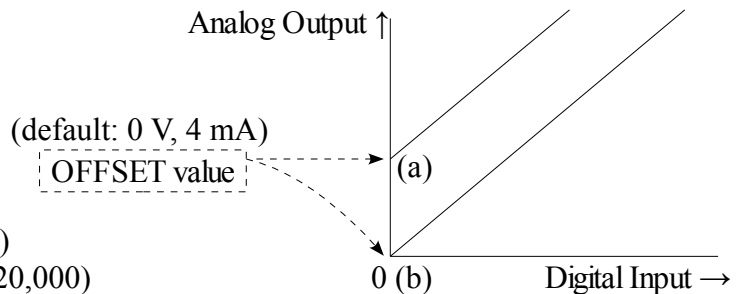

- **GAIN** determines the angle or slope of the calibration line, identified at a digital input value of 2000. The unit is mV or μ A.

Let the value of OFFSET = 0 :

- (c) Large gain = Large steps in analog outputs
- (d) Medium gain
- (e) Small gain = Small steps in analog outputs

Available range of GAIN:

Voltage output: [1V (+1,000) ~ 15V (+15,000)] + OFFEST

Current output: [4mA (+4,000) ~ 32mA (+32,000)] + OFFSET

(default: 5 V or 12 mA)

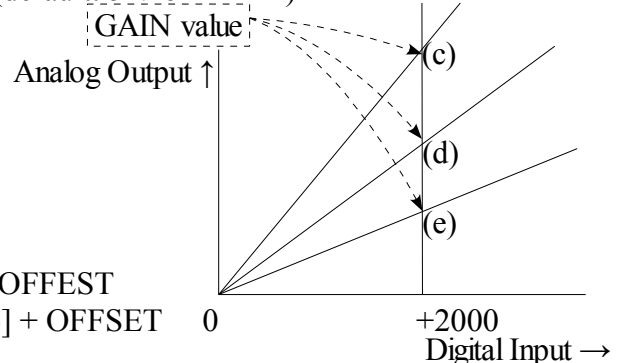

OFFSET and GAIN values can be set independently or together. And the values can be adjusted by user program in the VB series Main Unit (see the program Example #3).

- The following example is for defining the OFFSET and GAIN values:

Example #3: Via the program to set the CH1's OFFSET = 0 mA and GAIN = 10 mA, and the convert characteristic of CH2 still keeps the default setting.

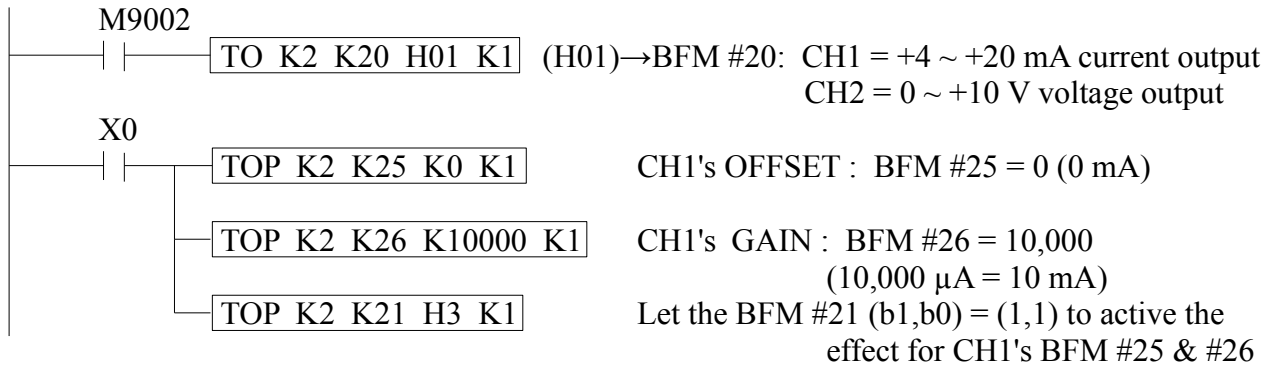

VIGOR ELECTRIC CORP.

Tel: 886-2-2620-4393 Fax: 886-2-2620-4976

<http://www.vigorplc.com>