

VB - 4AD

4 Channels

Analog Input Module

User Manual

Foreword

- This manual contains text, diagrams and explanations which will guide the reader in the correct installation, safe use and operation of the VB-4AD analog input module. It should be read and understood before attempting to install or use the unit.
- Further information can be found in the VIGOR M, VB and VH series PLC PROGRAMMING MANUAL.
- If in doubt at any stage during the installation of the VB-4AD analog input module always consult a professional electrical engineer who is qualified and trained to the local and national standards.
- If in doubt about the operation or use of the VB-4AD analog input module please consult the nearest VIGOR ELECTRIC CORP. distributor.
- This manual is subject to change without notice.

Features

- Provides 4 channels analog input, each one has 12-bit high precision resolution.
- The voltage (-10 V ~ +10 V) or current (-20 mA ~ +20 mA) input can be specified for each channel independently.
- The OFFSET and GAIN of each input channel can adjust independently.
- Equipped with a 10 V DC accurately standard voltage output (60 mA Max.), offers reference power source for the linear potentiometer.
- Photocoupler isolation between input analog signals and digital PLC circuits. Inner DC to DC isolated converter supplies the clean power.

Instruction

- VB-4AD Analog Input Module contains 4 channels of analog inputs. Each input channel receives an external analog (either voltage or current) signal then converts that to a 12-bit digital data for the PLC.
- Through the operation of the FROM / TO instruction, such digital data can be further transferred to the VB Series Main Unit for value monitoring or relative controls.
- Please read this user's manual carefully before using the VB-4AD Analog Inputs Module.
- The default modes are good enough for general applications, please refer to the Chapters #1 ~ #6; for a particular analog to digital transfer characteristic, please study the Chapter #7.

Contents:	Page:
<u>1. Specifications</u>	2
<u><< Power Input Requirement >></u>	2
<u><< 10 V Accurately Standard Voltage Output >></u>	2
<u><< Analog Input Performance Specification >></u>	2
<u><< Charts of A/D Converter Characteristic >></u>	3
<u>2. Dimensions</u>	3
<u>3. Wiring</u>	4
<u>4. Outline of FROM/TO Instruction</u>	5
<u>5. Allocation of Buffer Memory (BFM)</u>	6
<u>6. Operation and Program Example</u>	8
<u>7. Defining OFFSET and GAIN</u>	9

1. Specifications

<< Power Input Requirement >>

- 5 V DC (for internal control)
 - Supplied from PLC Main Unit (or Expansion Unit / VB-PWR) via its extension cable.
 - From a Main Unit:
 - [(The amount of Expansion Modules) + (The amount of Special Modules) X 2] ≤ 4
 - From a Expansion Unit or VB-PWR:
 - [(The amount of Expansion Modules) + (The amount of Special Modules) X 2] ≤ 12
- 24 V DC (±20%), 60 mA (Max.) (for analog signal output)
 - Supplied from external power supply or 24V DC output of PLC.

<< 10 V Accurately Standard Voltage Output >>

Output: 10 V DC ±0.5%, 60 mA (Max.)

<< Analog Input Performance Specification >>

Item	Voltage Input	Current Input
	Voltage or Current inputs are selected by BFM #0 and sliding switches	
Analog Input Range (DC)	-10 V ~ +10 V	-20 mA ~ +20 mA / +4 mA ~ +20 mA
Digital Output Range	-2000 ~ +2000	-2000 ~ +2000 / 0 ~ +2000
Input Resistance	200 kΩ	250 Ω
Resolution	5 mV	10 μA
Overall Accuracy	± 1% (full scale)	
Conversion Speed	0.5 ms × 1 ~ 4 activated point(s)	
Isolation	Photocoupler isolation between analog and digital circuits. DC/DC converter isolates of power from its power source. No isolation between analog channels.	
Absolute Max. Peak Rating	± 15 V	± 32 mA

<< Charts of A/D Converter Characteristic >>

The charts of several default A/D converted characteristics. (Which can be adjusted by using the approach specified at [Chapter #7: Defining OFFSET and GAIN.](#))

Mode 0: Voltage Input (Range: -10 V ~ +10 V)

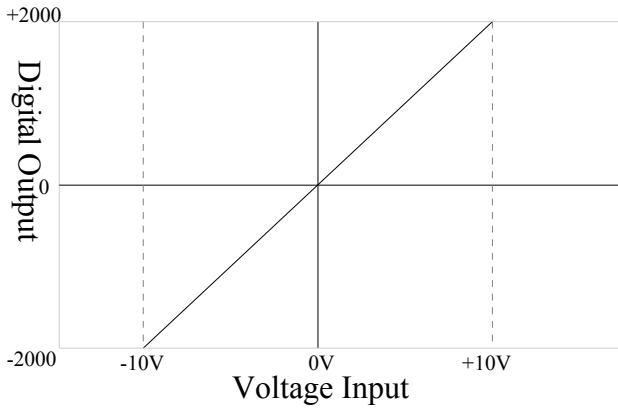

Mode 1: Current Input (Range: +4 mA ~ +20 mA)

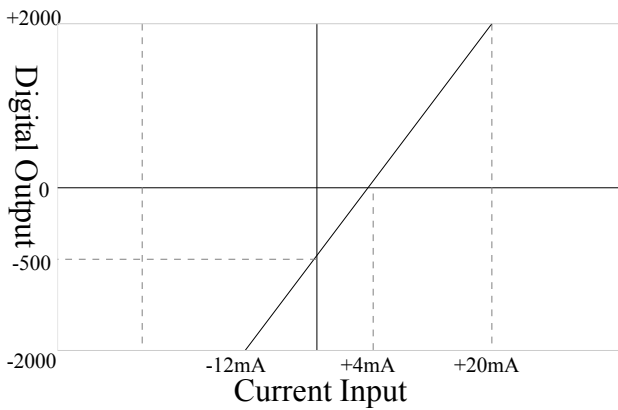

Mode 2: Current Input (Range: -20 mA ~ +20 mA)

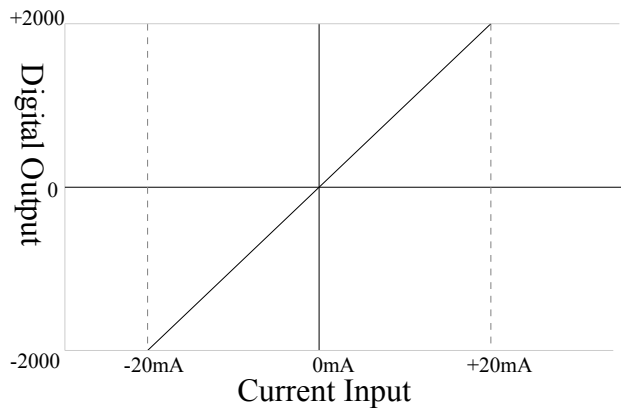

2. Dimensions

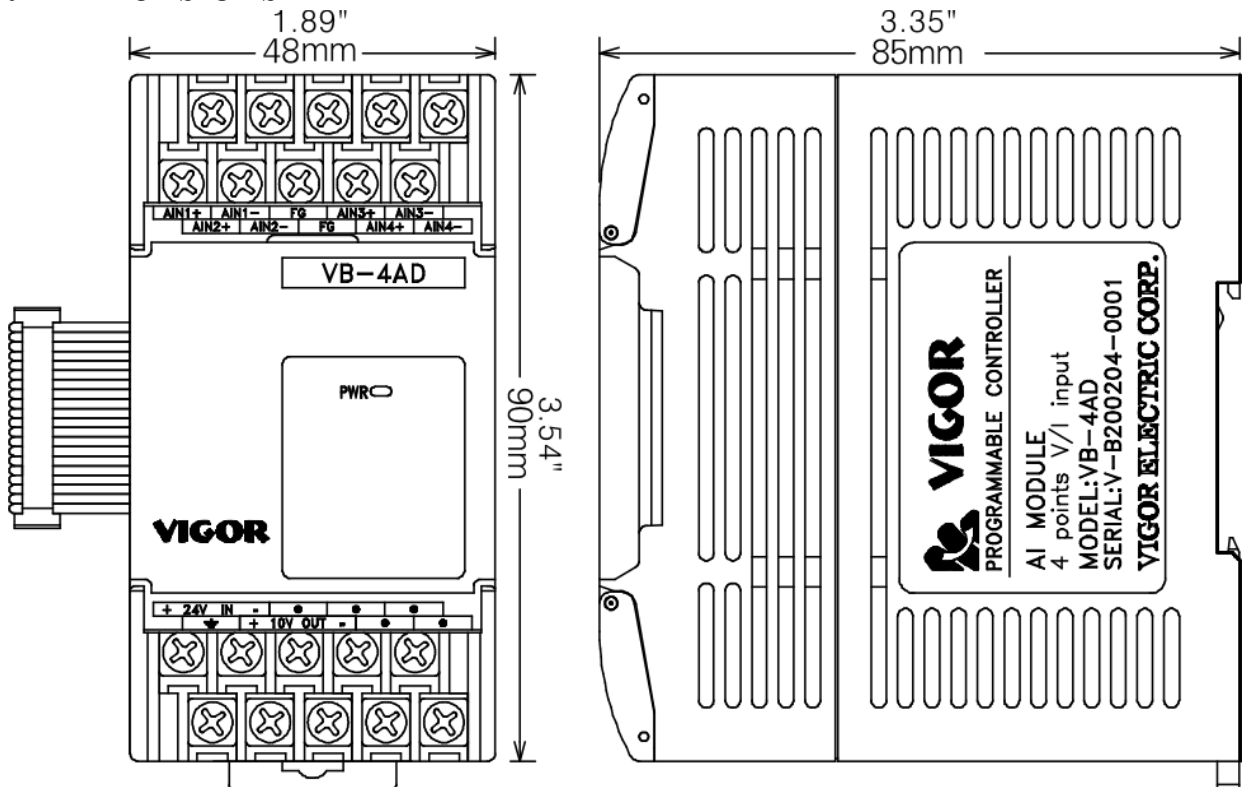

3. Wiring

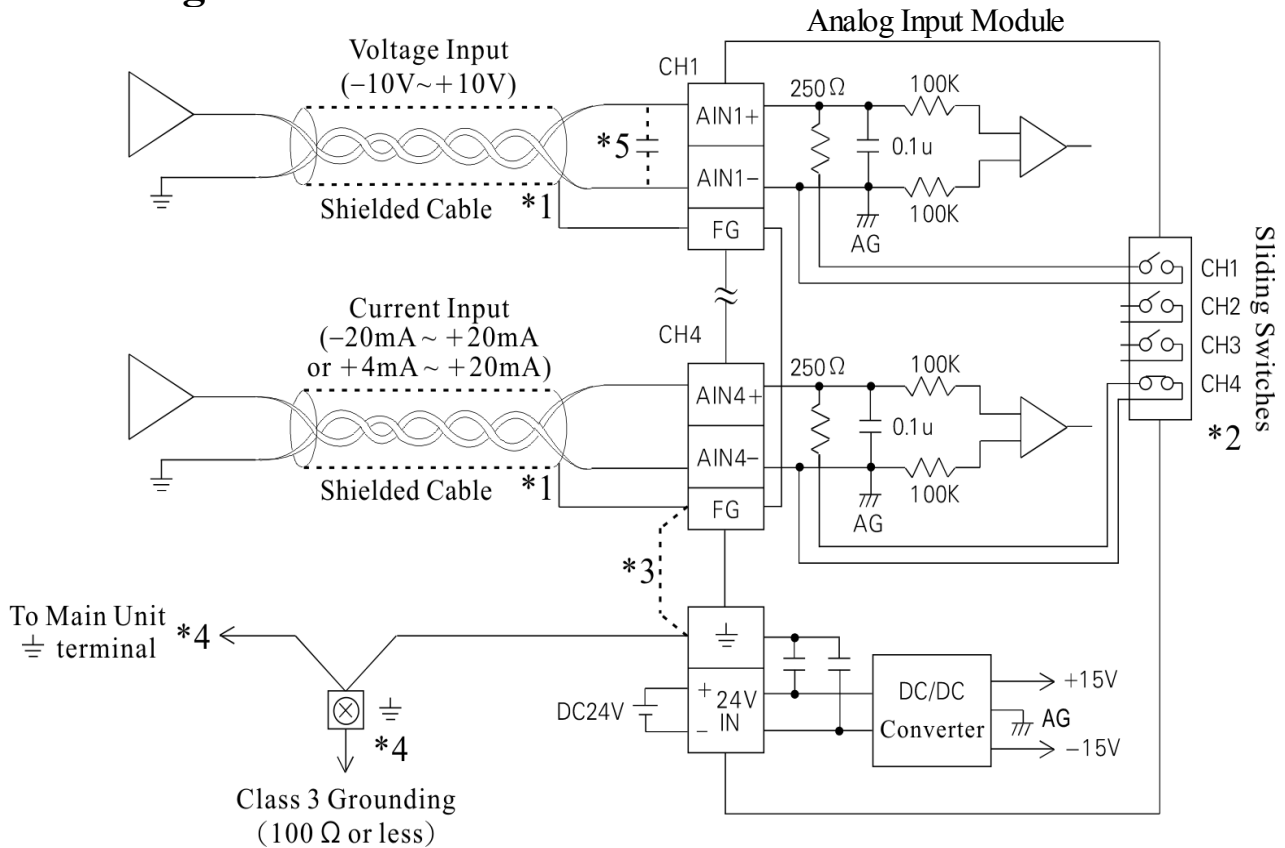

*1: Please use the Shield Twisted-Pair isolation cable for each analog input channel and keep the cable away from the electromagnetic interference source (ex. power lines or any other lines which may induce electrical noise). Apply 1-point grounding at the FG frame ground terminal of VB-4AD.

*2: Please pay attention to the following keynotes when to decide the input (voltage or current) of each channel.

- ① Adjust the appropriate mode setting of BFM #0 for each channel. (please refer to [Chapter #5 Allocation of Buffer Memory \(BFM\)](#))
- ② Adjust the appropriate position of sliding switch for each channel (which is located on the left side of the module).

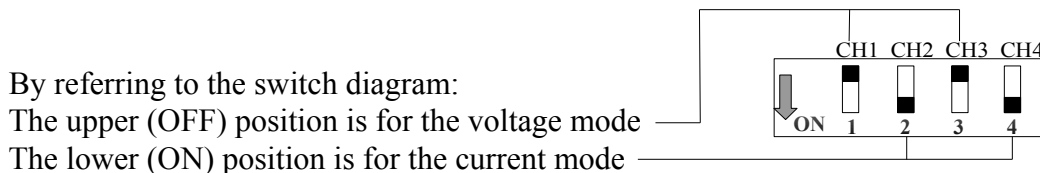



*3. If there is excessive electrical noise, connect the FG frame ground terminal with the grounded terminal on the VB-4AD.

*4. Connect the ground terminal \perp on the VB-4AD module with the grounded terminal \perp to the Main Unit. Use class 3 grounding on the Main Unit, if available.

*5. If a voltage ripple occurs during input or there is electrically induced noise on the external wiring, parallel connect with a smoothing capacitor ($0.1\mu \sim 0.47\mu\text{F}$, 25 V).

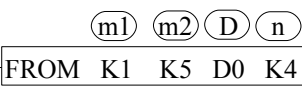
4. Outline of FROM/TO Instruction

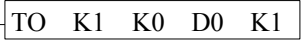
D	FNC 78 FROM	P		Read special module BFM												
Device																
	X	Y	M	S	KnX	KnY	KnM	KnS	T	C	D	SD	P	V,Z	K,H	VZ index
m1															○	
m2															○	
D						○	○	○	○	○	○					○
n															○	
<ul style="list-style-type: none"> • m1 = 1~8 • m2 = 0~32767 • n = 1~32767 																
X0	<p></p> <p>(m1): The position number of the specified special module (m2): Initial serial number of the BFM(s) to be read (D): The initial device of storage(s) for collect the picked up data (n): Number of data group(s) to be read</p>															
<ul style="list-style-type: none"> • The Main Unit of VB Series PLC use the instruction to read BFM data of the special module. • When X0="ON", 4 groups (they will be BFM #5 ~ #8, because (n) = K4 and (m2) = K5) data in the specified special module (which is installed in the (m1) = K1 = 1st position) will be read and stored into registers sequentially which are started from (D) = D0. • To assign the (m1) in a VB Series, each special module is consecutively assigned from K1 to K8 (in a VB0 Series, (m1) = K1 or K2), it begins with the closest one to the Main Unit. • When X0="OFF", the instruction will not be performed but the data (which was read previously) will still remain. 																
D	FNC 79 TO	P		Special module BFM write in												
Device																
	X	Y	M	S	KnX	KnY	KnM	KnS	T	C	D	SD	P	V,Z	K,H	VZ index
m1															○	
m2															○	
D					○	○	○	○	○	○	○				○	○
n															○	
<ul style="list-style-type: none"> • m1 = 1~8 • m2 = 0~32767 • n = 1~32767 																
X0	<p></p> <p>(m1): The position number of the specified special module (m2): Initial serial number of the BFM(s), which will be written (S): The initial source device, which stores the data is for the BFM (n): Number of data group(s) to be write</p>															
<ul style="list-style-type: none"> • The Main Unit of VB series PLC use this instruction to write data to the special module BFM. • When X0="ON", the content value of (S) (D0) will be written into the BFM #0 ((m2) = K0) in the special module and the it is installed in the 1st ((m1) = K1) position. Since (n) = K1, there is only one BFM will be written. • To assign the (m1) in a VB Series, each special module is consecutively assigned from K1 to K8 (in a VB0 Series, (m1) = K1 or K2), it begins with the closest one to the Main Unit. • When X0="OFF", the instruction will not be performed but the data (which was written previously) will still remain. 																

5. Allocation of Buffer Memory (BFM)

Data is transmitted between the VB-4AD and the Main Unit via buffer memories (BFM).

BFM	Description	
#0	To organize the input mode of CH #1 ~ CH #4 (with latch function). Default value = H0000	
#1	CH #1	<ul style="list-style-type: none"> ● Contains the number of samples to be used for an averaged result. ● The available rang is K1 ~ K32,767; otherwise = K32. ● Default value = K32 (when the PLC power, OFF→ON)
#2	CH #2	
#3	CH #3	
#4	CH #4	
#5	CH #1	<ul style="list-style-type: none"> ● These BFMs contain the averaged input values for the number of samples entered, they are from the channels CH1 ~ CH4 and bring the values of BFM #1 ~ #4 out respectively. (Read only)
#6	CH #2	
#7	CH #3	
#8	CH #4	

- The value of BFM #0 switches the modes between voltage or current analog input on each channel. It takes the form of a 4-digit hexadecimal number. The first digit will be the command for channel 1 (CH1), and the second digit for channel 2 (CH2), and so forth. The numeric values of these four digits respectively represent the following items:

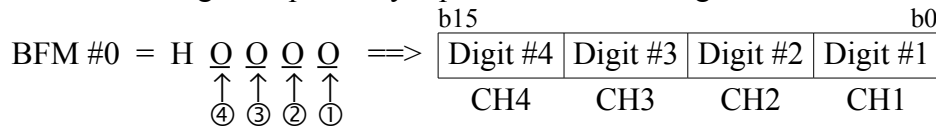

- When: Q = 0 : Sets the channel to voltage input mode (-10 V ~ +10 V).
 Q = 1 : Sets the channel to current input mode (+4 mA ~ +20 mA).
 Q = 2 : Sets the channel to current input mode (-20 mA ~ +20 mA).
 Q = 3 : Disables the channel.

Switching the output mode resets the I/O characteristics to the factory-set characteristics. Refer to the section of [<< Charts of A/D Converter Characteristic >>](#).

Example: Let the BFM #0 = H 3 2 1 0

- CH1 = 0 : Voltage output (-10 V ~ +10 V)
- CH2 = 1 : Current output (+4 mA ~ +20 mA)
- CH3 = 2 : Current output (-20 mA ~ +20 mA)
- CH4 = 3 : Disabled.

- The value of BFM #0 ~ #4 can be written from its Main Unit by using the TO instruction.
- The value of BFM #5 ~ #8 can be read to its Main Unit by using the FROM instruction.

BFM	Description
#9	To activate the excepted settings
#10	The OFFSET value of the CH1 (Default value = K0)
#11	The GAIN value of the CH1 (Default value = K5,000)
#12	The OFFSET value of the CH2 (Default value = K0)
#13	The GAIN value of the CH2 (Default value = K5,000)
#14	The OFFSET value of the CH3 (Default value = K0)
#15	The GAIN value of the CH3 (Default value = K5,000)
#16	The OFFSET value of the CH4 (Default value = K0)
#17	The GAIN value of the CH4 (Default value = K5,000)
#18	When its b0 = 1, all the A/D converted characteristics will be returned to the default values.
#19	When the content values of BFM #1 ~ #4 are between 1~32,767, the b11 = OFF; Otherwise = ON. (Read only)
#20~29	Reserved, do not use.
#30	Model code: K101 (Read only)

- When to trigger the BFM #18, b0 = 1, all the analog to digital converted characteristics (including CH1 ~ CH4) will be returned to the default values. If a user sets incorrect converted characteristics to a VB-4AD, to trigger the BFM #18, b0 =1 which can reset all the converted characteristics back to their default settings.
- When to trigger the BFM #9 (b1,b0) = (1,1), the content values of BFM #10 and #11 (which are the converted characteristics for CH1) will be activated and recorded to the EEPROM. And so forth, the b2 ~ b7 in the BFM #9 can use the same effect on the CH2 ~ CH4, which may be set up the CH1 ~ CH4 respectively or simultaneously.

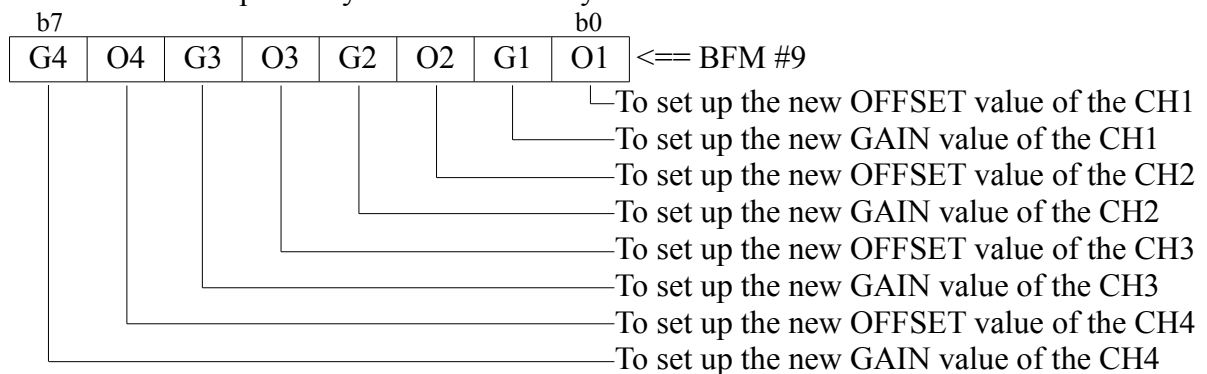

- The settings of BFM #10 ~ #17 shall be in the unit of mV or μA , which are specified by the input mode of BFM #0.
- The BFM #9 ~ #18 can be written from its Main Unit by using the TO instruction; the BFM#19 and BFM #30 can be read to its Main Unit by using the FROM instruction.
- To adjust the conversion characteristics. First, the OFFSET value and GAIN value of the channel are required to be written (in BFM #10 ~ #17); and then, to trigger the corresponding bit in BFM #9.

Cautions

- The content value of BFM #0, OFFSET and GAIN settings (BFM #10 ~ #17) of each channel will be kept in EEPROM of the VB-4AD module. Also, to reset the settings by BFM #18 will rewrite the data in EEPROM. The rewrite times of EEPROM is 10,000 times approximately; to operate those BFMs (#0, 9 and 18) should pay attention to this limitation of EEPROM.
- Writing data into an EEPROM will take longer time. So between two rewrite commands for the EEPROM, must make an interval (more than one second).

6. Operation and Program Example

To operate the VB-4AD by its default values can using the following simple example programs.

Example #1

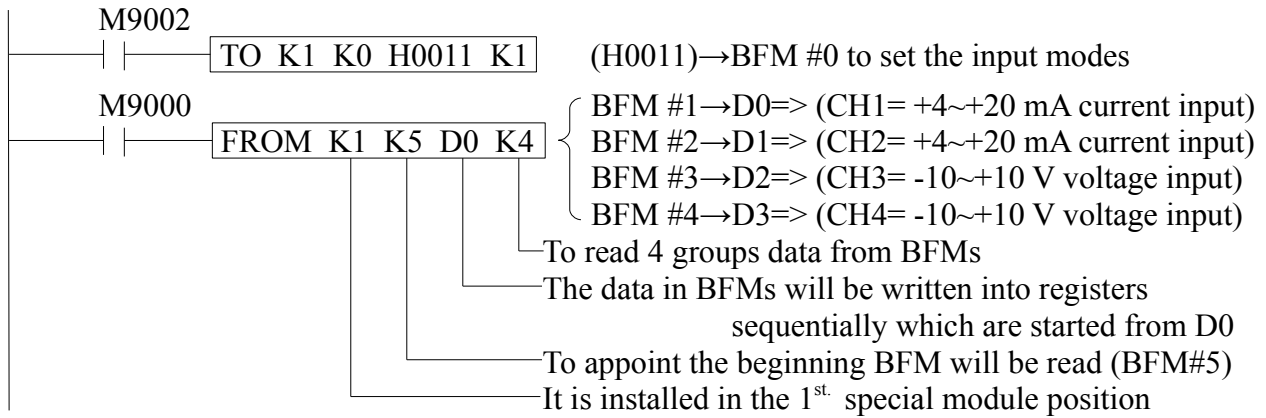

- At this program, the CH1 and CH2 are assigned to the +4 ~ +20 mA current inputs; the CH3 and CH4 are assigned to the -10 ~ +10 V voltage inputs. Since the program doesn't give the average times for results, the results will be generated from the average of 32 times.
- Operation procedure:
 - ① First at all, to adjust the appropriate position of sliding switch on the VB-4AD for each channel (which is located on the left side of the module).
 - ② Turn OFF the power of the Main Unit, and then connect with the VB-4AD. After that, wire the I/O and power lines of the VB-4AD. Set the Main Unit to STOP, and turn ON the power. To download the above program then switch the Main Unit to RUN.
 - ③ Analog value of input channels will be read from the VB-4AD and put the values to D0 (BFM #1), D1 (BFM #2), D2 (BFM #3) and D3 (BFM #4) in the Main Unit.
 - ④ To check the digital values of D0, D1, D2 and D3, those are the analog inputs of VB-4AD.

Example #2

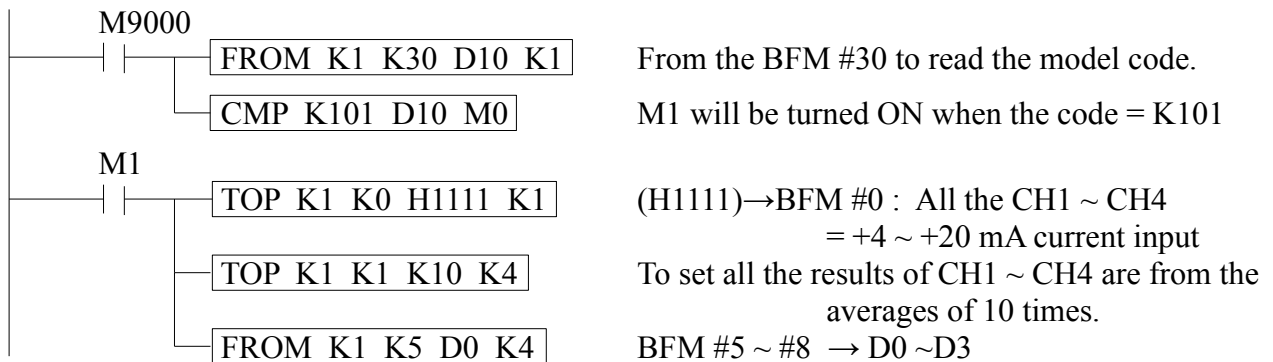

Cautions Regarding Operation

- ① Check whether the input wiring and/or expansion cables are properly connected on VB-4AD module. (Refer to the [Chapter #3. Wiring](#))
- ② Check that the VB system configuration rules have not been broken, i.e. the number of modules does not exceed 8.
- ③ Ensure that the correct input mode and switch position have been selected for the application.
- ④ Check there is no power overload on either the 5 V or 24 V << [Power Input Requirement](#) >>, remember the loading on the VB Main Unit or a powered extension unit varies according to the number of extension units or special function units connected.

7. Defining OFFSET and GAIN

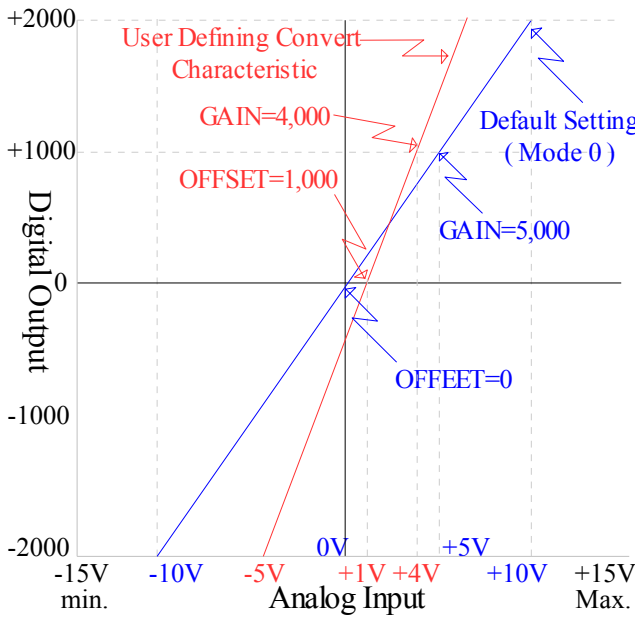

A/D Conversion Chart of Voltage Input Modes

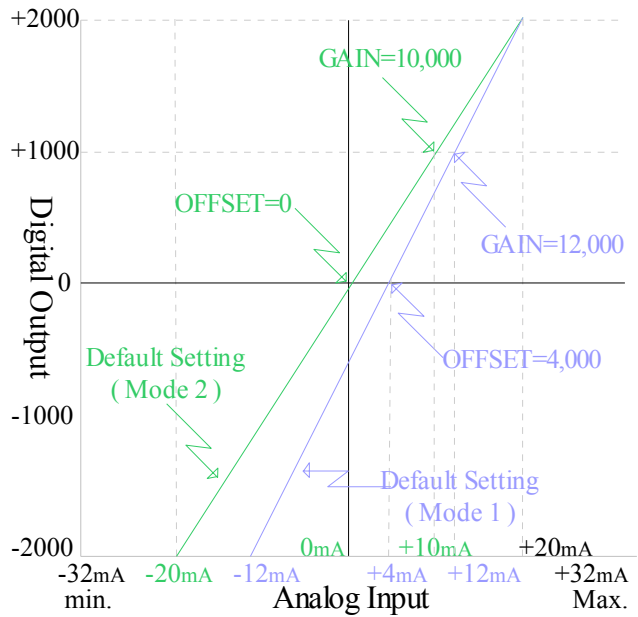

A/D Conversion Chart of Circuit Input Modes

The two diagrams above represent Analog to Digital conversion characteristic charts of the voltage input mode and the circuit input mode. Users may adjust those conversion characteristic charts depending on actual needs for particular application. To change the OFFSET value and GAIN value, the adjustment principles are specified as follows:

- **OFFSET** is the 'Position' of the calibrated line, identified at a digital output value of 0. The unit is mV or μ A.

- Negative offset
- Zero offset
- Positive offset

Available range of OFFSET:

Voltage input: -5 V (-5,000) ~ +5 V (+5,000)

Current input: -20 mA (-20,000) ~ +20 mA (+20,000)

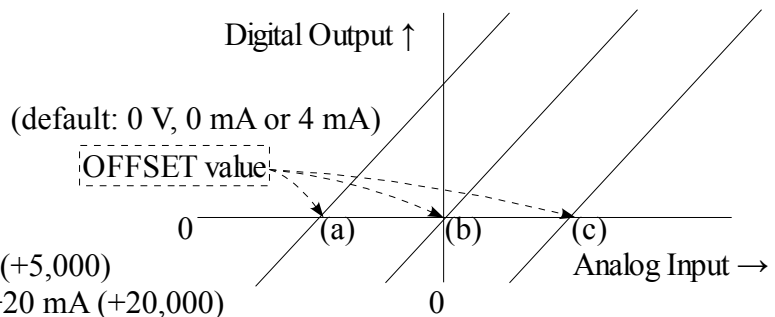

- **GAIN** determines the angle or slope of the calibration line, identified at a digital output value of 1000. The unit is mV or μ A.

Let the value of OFFSET = 0 :

- Small gain = Large steps in digital readings
- Medium gain
- Large gain = Small steps in digital readings

Available range of GAIN:

Voltage input: [1V (+1,000) ~ 15V (+15,000)] + OFFSET

Current input: [4mA (+4,000) ~ 32mA (+32,000)] + OFFSET

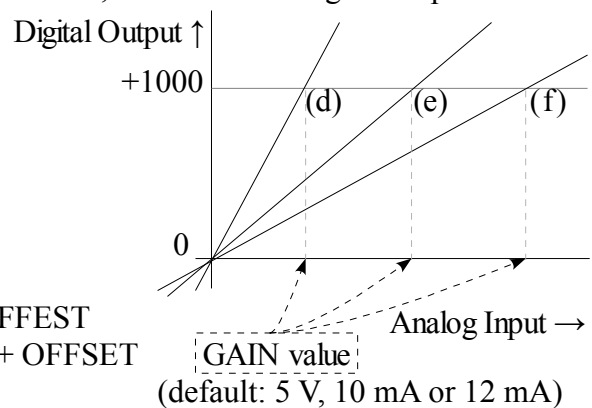

OFFSET and GAIN values can be set independently or together. And the values can be adjusted by user program in the VB series Main Unit (see the program Example #3 and #4).

- The following examples are for defining the OFFSET and GAIN values:

Example #3: Via the program to set the CH1's OFFSET = 0 V and GAIN = 2.5 V

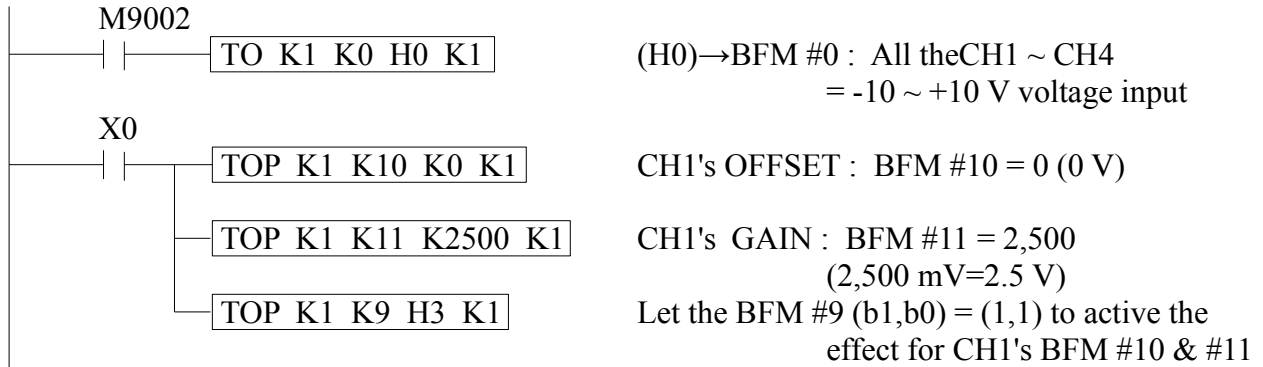

Example #4: Via the program to set the CH2's OFFSET = 2 mA and GAIN = 18 mA

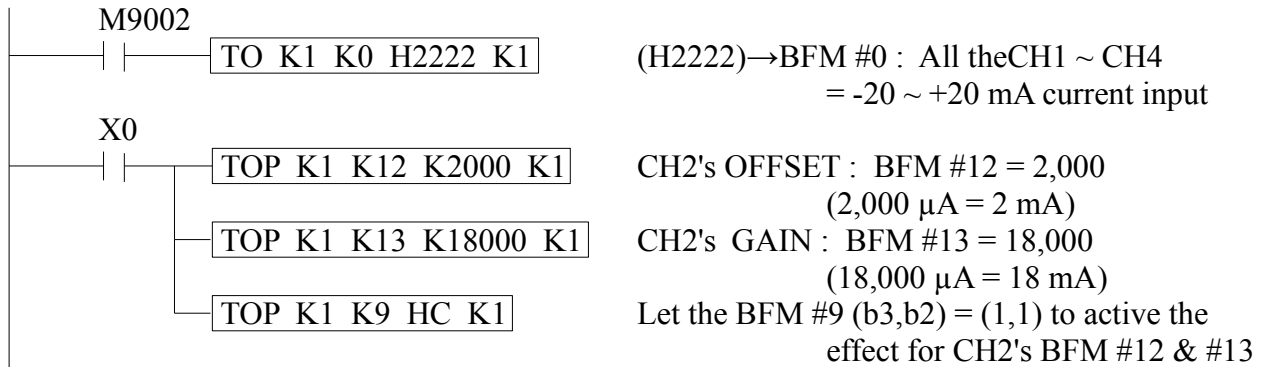

VIGOR ELECTRIC CORP.

Tel: 886-2-2620-4393 Fax: 886-2-2620-4976

<http://www.vigorplc.com>